

Type designation: Three phase isolating transformer 5000 VA / 3x 400 V / 3x 400 V
 Type: DTTV 5000
 Item number: 1068

Standard: VDE 0570 Teil 2-4, EN 61558-2-4
 Version: transportable
 Construction: encapsulated with high insulating polyurethane, crane eyes, transport rollers
 Short circuit strength: non inherently short circuit proof
 Fuse input: Transformer circuit breaker
 Max. ambient temperature: + 40°C
 Insulation class: E
 Protection index: IP 44
 Safety class: 2
 Vector group: Dyn5
 Weight approximately: 100 kg
 Dimensions approximately: 340 x 415 x 640 mm (width x height x depth)
 Connection input: 2 m power cable with CEE plug rot / 400 V / 50-60 Hz / 16 A / 5 Pole / 6 H
 Connection output: CEE socket red / 400 V / 50-60 Hz / 16 A / 5 Pole / 6 H

Power: 5000 VA
 Input voltage: 3x 400 V
 Output voltage: 3x 400 V (3x 230 V to N)
 Output current: 3x 7,22 A
 Frequency: 50-60 Hz

Application: The three phase isolating transformer guaranteed the safe galvanic isolation of the input and output sides.
 Isolating transformers may be used to set up protective separation as a protective measure in accordance with VDE 0100 or to build IT-net systems.

Optional on request: Country-specific voltages, encapsulated version for protection index IP 65 connections on terminals + tapping +/- 5% for voltage adjustment

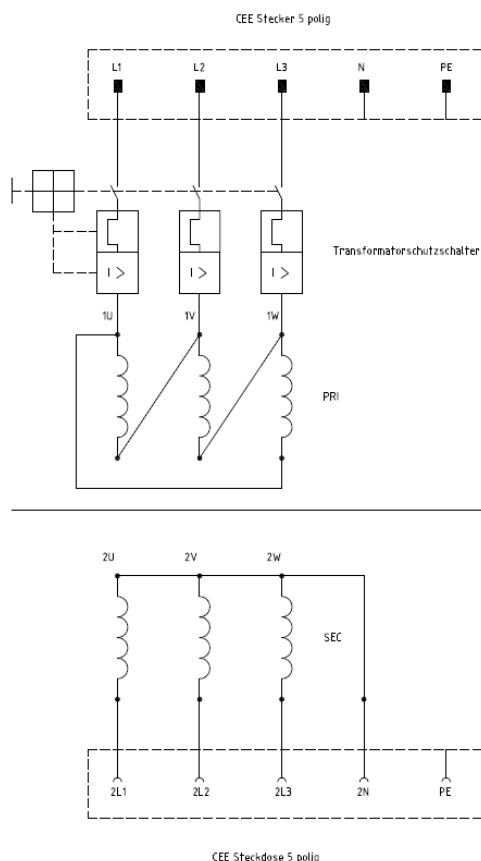

Subjects to change!
 Original may differ from photo!